

Industrial Ethernet Switch - FL SWITCH 1605 M12 - 2700200

Please be informed that the data shown in this PDF Document is generated from our Online Catalog. Please find the complete data in the user's documentation. Our General Terms of Use for Downloads are valid (<http://phoenixcontact.com/download>)



Ethernet switch, 5 Ethernet ports on the front in M12 format, automatic detection of 10 or 100 Mbps data transmission rate, coupling of network segments with different transmission speeds, auto crossing function, IP67 protection

Product Description

Ethernet interface:

The FL SWITCH 1605 M12 has five Ethernet ports on the front in M12 format, to which only CAT5/CAT6 Ethernet cables with D-coded M12 connectors can be connected. The data transmission speed is 10 Mbps or 100 Mbps. In addition, each port has an autocrossing function at 100 Mbps. It is not necessary to distinguish between 1:1 and crossover Ethernet cables.

Switching properties of the FL SWITCH 1605 M12

- Store and forward:

The switch independently learns the addresses for terminal devices, which are connected via a port, by evaluating the source addresses in the data telegrams. Only packets with unknown addresses, with a source address of this port or with a multicast/broadcast address in the destination address field are forwarded via the corresponding port. The switch can store up to 4096 addresses in its address table with an aging time of 40 seconds. This is important if more than one terminal device is connected to one or more ports. In this way, several independent subnets can be connected to one switch.

- Multi-address function:

The switch independently learns the addresses for terminal devices, which are connected via a port, by evaluating the source addresses in the data telegrams. Only packets with unknown addresses, with a source address of this port or with a multicast/broadcast address in the destination address field are forwarded via the corresponding port. The switch can store up to 4096 addresses in its address table with an aging time of 40 seconds. This is important if more than one terminal device is connected to one or more ports. In this way, several independent subnets can be connected to one switch.

- Quality of Service (QoS)

With the aid of the Quality of Service function, the switch can process PROFINET traffic preferentially. To do this, the switch detects the QoS priority from the Ethernet packets and forwards the Ethernet packets with higher priority first.

Your advantages

- ✓ Robust IP67 housing
- ✓ Easy panel mounting

Key Commercial Data

Packing unit	1 pc
GTIN	 4 046356 499781
GTIN	4046356499781
Weight per Piece (excluding packing)	280.000 g

Industrial Ethernet Switch - FL SWITCH 1605 M12 - 2700200

Custom tariff number	85176200
Country of origin	China

Technical data

Dimensions

Caption	Top view (dimensions in mm)
Width	30 mm
Height	200 mm
Depth	41 mm

Ambient conditions

Degree of protection	IP65
	IP66
	IP67
Ambient temperature (operation)	-40 °C ... 70 °C
Ambient temperature (storage/transport)	-40 °C ... 70 °C
Permissible humidity (operation)	10 % ... 95 %
Permissible humidity (storage/transport)	10 % ... 95 % (non-condensing)
Air pressure (operation)	86 kPa ... 108 kPa (2000 m above sea level)
Air pressure (storage/transport)	66 kPa ... 108 kPa (3500 m above sea level)

Function

Basic functions	Unmanaged switch/auto negotiation, complies with standard IEEE 802.3, store-and-forward switching mode, 2 priority classes according to IEEE802.1p, PTCP filter
Additional functions	Autonegotiation
PROFINET conformance class	Conformance-Class A
Status and diagnostic indicators	LEDs: US (power supply), 2 LEDs per Ethernet port (Link and Activity)

Network expansion parameters

Cascading depth	Network, linear, and star structure: any
Maximum conductor length (twisted pair)	100 m

Supply voltage

Supply voltage	24 V DC (M12 connector)
Residual ripple	3.6 V _{PP}
Supply voltage range	9 V DC ... 32 V DC
Typical current consumption	40 mA (at U _S = 24 V DC)
Max. current consumption	40 mA (+10 mA per port)
Current consumption	40 mA ... 80 mA (at 24 V DC)

General

Mounting type	Wall mounting
---------------	---------------

Industrial Ethernet Switch - FL SWITCH 1605 M12 - 2700200

Technical data

General

Type AX	Stand-alone
Net weight	220 g
Housing material	PBT
Material base plate	High-grade steel (1.4301/1.4016)
Note	NOTE: Meet noise immunity requirements Connect FE using a mounting screw when mounting on a conductive surface. When mounting on a non-conductive surface, FE is connected using the mounting screw via a cable lug.
MTTF	302.5 Years (SN 29500 standard, temperature 25°C, operating cycle 21%)
	156.52 Years (SN 29500 standard, temperature 40°C, operating cycle 34.25%)
	40.43 Years (SN 29500 standard, temperature 55°C, operating cycle 100%)

Standards and Regulations

Electromagnetic compatibility	Conformance with EMC Directive 2014/30/EU
Type of test	Shock in acc. with EN 60068-2-27/IEC 60068-2-27
Test result	Operation: 30g, 6 ms continuous testing, 5g 30 ms continuous testing
Type of test	Shock in acc. with EN 60068-2-27/IEC 60068-2-27
	Vibration resistance in acc. with EN 60068-2-6/IEC 60068-2-6
Test result	Operation/Storage/Transport: 5g, 150 Hz, Criterion 3
Type of test	Free fall in acc. with IEC 60068-2-32
Test result	0.5 m
Type of test	Vibration resistance according to IEC 61373, EN 61373
Test result	Category 1, Class B
Noise emission	EN 61000-6-4
Noise immunity	EN 61000-6-2
Connection in acc. with standard	CUL

Environmental Product Compliance

REACH SVHC	Lead 7439-92-1
China RoHS	Environmentally Friendly Use Period = 50 years
	For details about hazardous substances go to tab "Downloads", Category "Manufacturer's declaration"

Drawings

Industrial Ethernet Switch - FL SWITCH 1605 M12 - 2700200

Schematic diagram

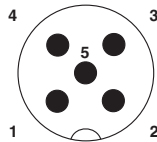

Connecting the supply voltage
 PIN 1 Us
 PIN 2 n.c.
 Pin 3 GND
 Pin 4 n.c.
 Pin 5 functional ground

Schematic diagram

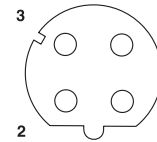

Assignment of the LAN socket
 Pin 1 Transmit +
 Pin 2 Receive +
 Pin 3 Transmit -
 Pin 4 Receive -

Dimensional drawing

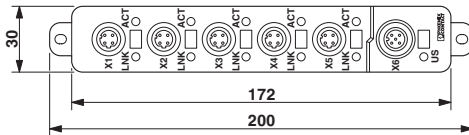

Top view (dimensions in mm)

Dimensional drawing

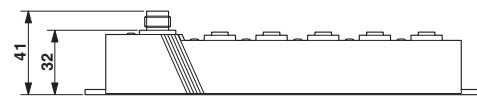

Side view (dimensions in mm)

Product drawing

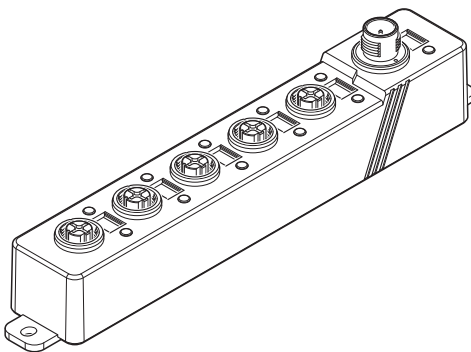

Product drawing

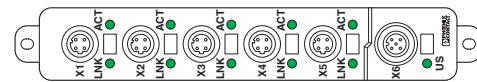

X1 - X5: Ethernet connection
 X6: Supply voltage
 ACT: ACT LEDs
 LNK: Link LED
 US: U_{S1} LED

Classifications

eCl@ss

eCl@ss 10.0.1	19170402
eCl@ss 11.0	19170402
eCl@ss 4.0	24010500
eCl@ss 4.1	24010500
eCl@ss 5.0	19030100
eCl@ss 5.1	19030100

Industrial Ethernet Switch - FL SWITCH 1605 M12 - 2700200

Classifications

eCl@ss

eCl@ss 6.0	19170100
eCl@ss 7.0	19170106
eCl@ss 9.0	19170106

ETIM

ETIM 4.0	EC000734
ETIM 6.0	EC000734
ETIM 7.0	EC000734

UNSPSC

UNSPSC 6.01	43172015
UNSPSC 7.0901	43201404
UNSPSC 11	43172015
UNSPSC 12.01	43201410
UNSPSC 13.2	43222612
UNSPSC 18.0	43222612
UNSPSC 19.0	43222612
UNSPSC 20.0	43222612
UNSPSC 21.0	43222612

Approvals

Approvals

Approvals

UL Recognized / cUL Recognized / EAC / cULus Recognized

Ex Approvals

Approval details

UL Recognized		http://database.ul.com/cgi-bin/XYV/template/LISEXT/1FRAME/index.htm	FILE E 140324
---------------	---	---	---------------

Industrial Ethernet Switch - FL SWITCH 1605 M12 - 2700200

Approvals

cUL Recognized		http://database.ul.com/cgi-bin/XYV/template/LISEXT/1FRAME/index.htm	FILE E 140324
----------------	--	---	---------------

EAC			RU*-DE.*.B.00741/19
-----	--	--	---------------------

cULus Recognized			
------------------	--	--	--

Accessories

Accessories

Circular connector (cable-side)

Data connector - SACC-MSD-4QO SH PN SCO - 1411068



Data connector, PROFINET CAT5 (100 Mbps), 4-position, halogen-free, shielded, Plug straight M12 SPEEDCON, Coding: D, Insulation displacement connection, knurl material: Zinc die-cast, nickel-plated, external cable diameter 5 mm ... 9.7 mm

Data connector - SACC-M12MRD-4Q SH - 1553624



Data connector, Ethernet CAT5 (100 Mbps), 4-position, shielded, Plug angled M12, Coding: D, Insulation displacement connection, knurl material: Nickel-plated brass, external cable diameter 4 mm ... 8 mm

Connector - SACC-M12MS-5PL M - 1424649



Connector, Universal, 5-position, unshielded, Plug straight M12, Coding: A, Push-lock spring connection, knurl material: Zinc die-cast, nickel-plated, external cable diameter 4 mm ... 8 mm

Industrial Ethernet Switch - FL SWITCH 1605 M12 - 2700200

Accessories

Connector - SACC-M12MR-5PL M - 1424651



Connector, Universal, 5-position, unshielded, Plug angled M12, Coding: A, Push-lock spring connection, knurl material: Zinc die-cast, nickel-plated, external cable diameter 4 mm ... 8 mm

Data cable preassembled

Network cable - NBC-MSD SCO/.../... - 1408713



Network cable, Ethernet CAT5 (100 Mbps), 4-position, shielded, Plug straight M12 SPEEDCON / IP67, coding: D, on free cable end, cable length: Free input (0.2 ... 40.0 m)

Network cable - NBC-MSD-MSD SCO/.../... - 1408706



Network cable, Ethernet CAT5 (100 Mbps), 4-position, shielded, Plug straight M12 SPEEDCON / IP67, coding: D, on Plug straight M12 SPEEDCON / IP67, coding: D, cable length: Free input (0.2 ... 40.0 m)

Network cable - NBC-MSD-MRD SCO/.../... - 1408700



Network cable, Ethernet CAT5 (100 Mbps), 4-position, shielded, Plug straight M12 SPEEDCON / IP67, coding: D, on Plug angled M12 SPEEDCON / IP67, coding: D, cable length: Free input (0.2 ... 40.0 m)

Network cable - NBC-MSD-R4AC SCO/.../... - 1408712



Network cable, Ethernet CAT5 (100 Mbps), 4-position, Variable cable type, shielded, Plug straight M12 SPEEDCON / IP67, coding: D, on Plug straight RJ45 / IP20, cable length: Free input (0.2 ... 40.0 m)

Industrial Ethernet Switch - FL SWITCH 1605 M12 - 2700200

Accessories

Data plug

Control cabinet feed-through - CUC-BH-M12D1PBK-A/R4BE - 1414397



Control cabinet feed-through, M12, 4-pos., D-coded to RJ45 socket, socket entry: 90°, IP65/IP67

Plug for cable screw gland

Screw plug - PROT-M12 - 1680539



An M12 screw plug for the unoccupied M12 sockets of the sensor/actuator cable, boxes and flush-type connectors

Sensor/actuator cable

Sensor/actuator cable - SAC-5P-FS SCO/.../... - 1536489



Sensor/actuator cable, 5-position, Variable cable type, free cable end, on Socket straight M12 SPEEDCON, coding: A, cable length: Free input (0.2 ... 40.0 m)

Sensor/actuator cable - SAC-5P-M12FR/.../... - 1697124



Sensor/actuator cable, 5-position, Variable cable type, free cable end, on Socket angled M12, coding: A, cable length: Free input (0.2 ... 40.0 m)

Industrial Ethernet Switch - FL SWITCH 1605 M12 - 2700200

Accessories

Sensor/actuator cable - SAC-5P-MS-FS SCO/.../... - 1523625



Sensor/actuator cable, 5-position, Variable cable type, Plug straight M12 SPEEDCON, coding: A, on Socket straight M12 SPEEDCON, coding: A, cable length: Free input (0.2 ... 40.0 m)

Sensor/actuator cable - SAC-5P-MS-FR SCO/.../... - 1542415



Sensor/actuator cable, 5-position, Variable cable type, Plug straight M12 SPEEDCON, coding: A, on Socket angled M12 SPEEDCON, coding: A, cable length: Free input (0.2 ... 40.0 m)

Terminal marking

Zack Marker strip, flat - ZBF 8:UNBEDRUCKT - 0808781



Zack Marker strip, flat, Strip, white, unlabeled, can be labeled with: PLOTMARK, CMS-P1-PLOTTER, mounting type: snap into flat marker groove, for terminal block width: 8 mm, lettering field size: 5.15 x 8.15 mm, Number of individual labels: 10

Y-distributor

Y distributor - SAC-5PY-F/M-F VP SH - 1419933



Y distributor, 5-position, shielded, Socket straight M12 SPEEDCON, coding: A, on Socket straight M12 SPEEDCON, coding: A and Plug straight M12 SPEEDCON, coding: A, Parallel distributor